

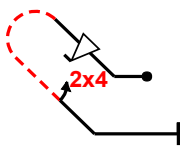

	Form A
Pilot ID	CIVA Advanced Free Known
	Flight #

No	Symbol	Cat. No.	K	Total K	Marks	Remarks	Pos	Item	K	Grade
1		8.4.18.1 9.9.2.4 9.4.4.2	14 13 5	Fig B 32				Pos.	30	
2		1.2.6.1 9.4.1.2 9.1.4.4	14 9 8	31				Fig K		Total K
								320		350
3		5.2.1.1 9.1.1.2 9.9.5.2	17 8 11	36				Penalties		
								Too Low		
								Too High		
								Interruptions		
								Insertions		
								Trg Violation		
								Wing Rocks		
								Disqual Fig		
								Other(note...)		
4		5.3.2.1 9.1.2.2 9.8.1.1 9.4.5.2	24 6 7 5	Fig C 42				Final Freestyle		
5		8.8.2.1 9.1.5.1	19 2	21				Duration	Min	Sec
6		1.2.8.3 9.11.1.6 9.1.2.1 9.4.2.3	15 3 4 10	Fig D 32				Judges Details		
								Signature		
								Name		
								Number		
7		7.5.7.4 9.1.2.6 9.2.3.6	15 12 12	39						
8		7.2.4.2 9.1.3.1 9.1.3.3 9.1.3.6 9.9.3.4	6 2 6 10 11	Fig A 35						
9		7.5.2.1 9.1.4.2 9.2.3.4	15 4 9	28						
10		2.2.3.2	24	Fig E 24						

_____ Pilot
 A/C

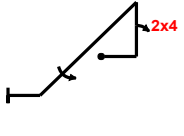
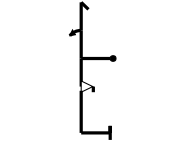
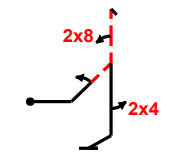
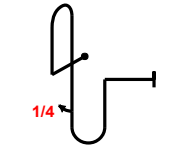
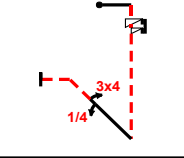
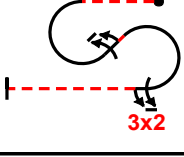
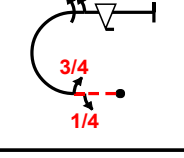
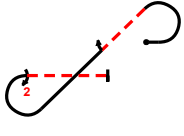
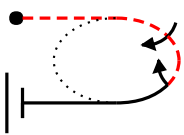

		Form B
Pilot ID	CIVA Advanced Free Known	Flight #

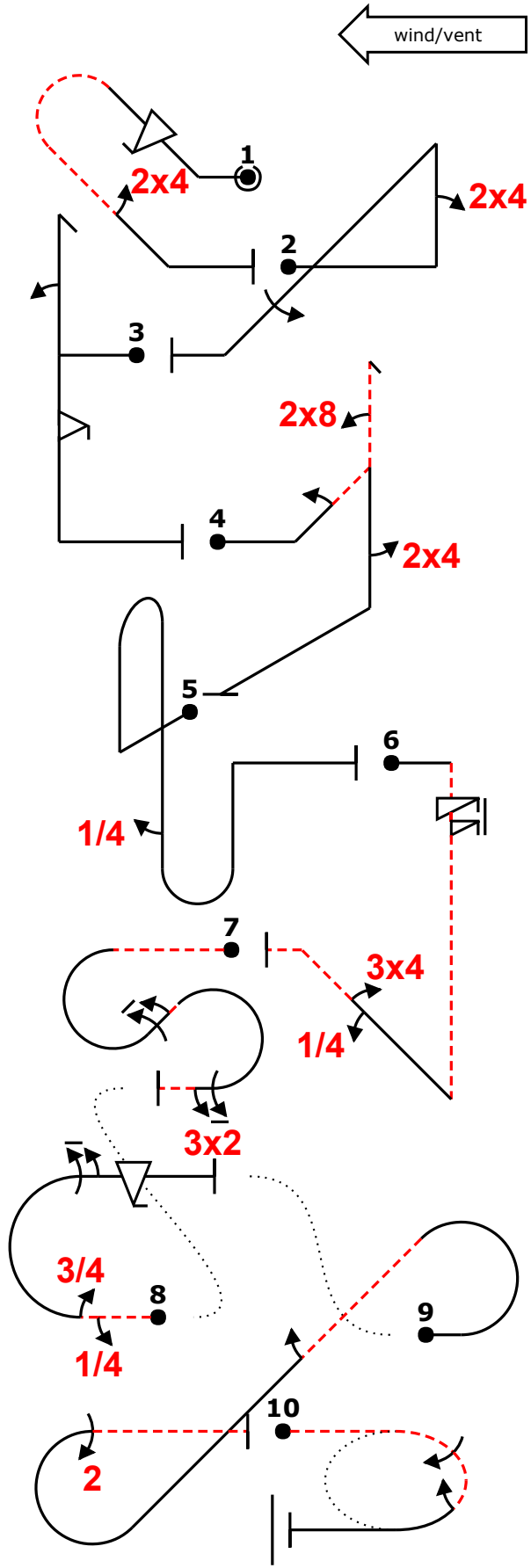

— Pilot —
 A/C



		Form C
Pilot ID	CIVA Advanced Free Known	Flight #

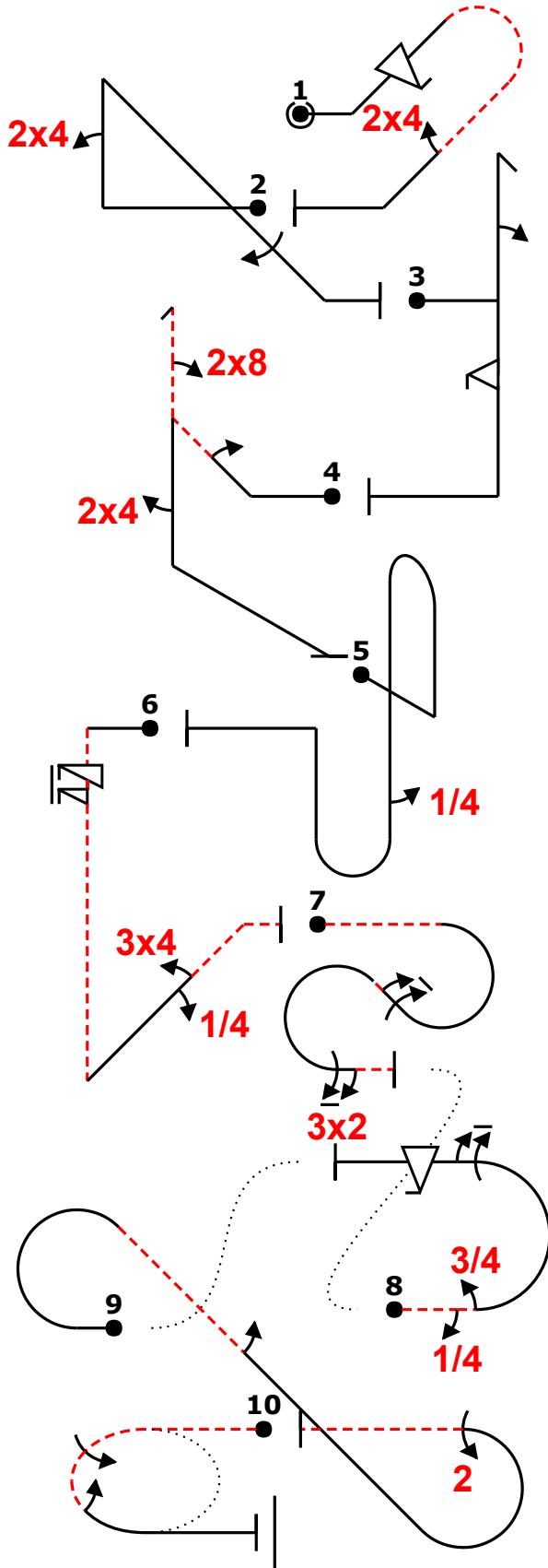
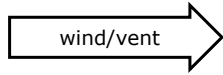

 Pilot
 A/C